

CupboardsExpress



Quick Custom Kitchens

Edmonton North

Showroom & Manufacturing
EdmontonNorth@CupboardsExpress.com
13030 - 146 Street,
Edmonton, AB
780.413.2260

Red Deer

Showroom
RedDeer@CupboardsExpress.com
101, 6660 Taylor Drive,
Red Deer, AB
403.986.6464

Calgary North

Showroom & Warehouse
CalgaryNorth@CupboardsExpress.com
Bay C, 2020 - 32 Avenue,
Calgary, AB
587.353.9904

Edmonton South

Showroom
EdmontonSouth@CupboardsExpress.com
4607 - 99 Street,
Edmonton, AB
780.432.2511

Calgary South

Showroom
CalgarySouth@CupboardsExpress.com
1307 - 11501 Buffalo Run Blvd
Tsuut'ina, AB
587.775.4650

Proudly Alberta Made Since 1958

MAPLE DOORS

Maple cabinets have a fine, indistinct grain making it a popular choice for contemporary designs. This hard, light coloured wood is finished to a fine luster. Although generally understated, maple develops a sophisticated character when treated with dark, penetrating stains.

Colours may vary slightly depending on your viewing device

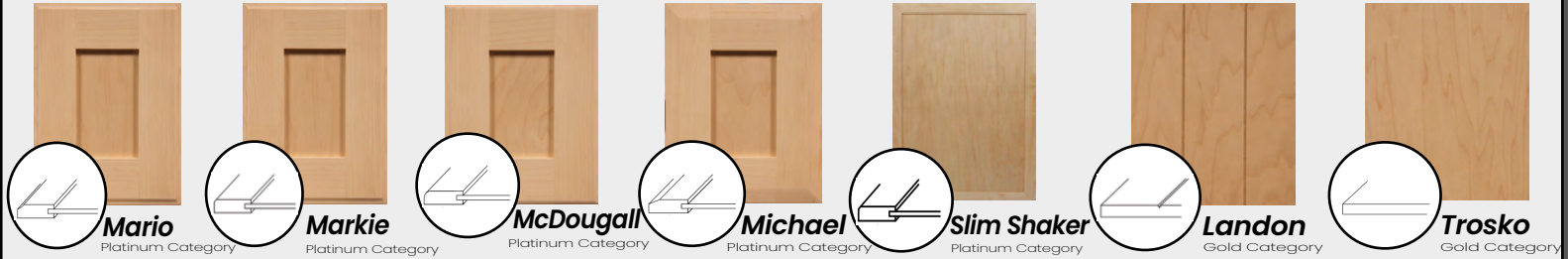

OAK DOORS

Oak is a favourite for its strength, stability and consistency. Stains accentuate its distinctive grain for a timeless look and unmatched durability.



STAIN OPTIONS



Earth Series



HICKORY DOORS

With its rich colour variation and distinguished dark lines, hickory provides a unique look. It takes stains consistently and is exceptionally strong and durable.

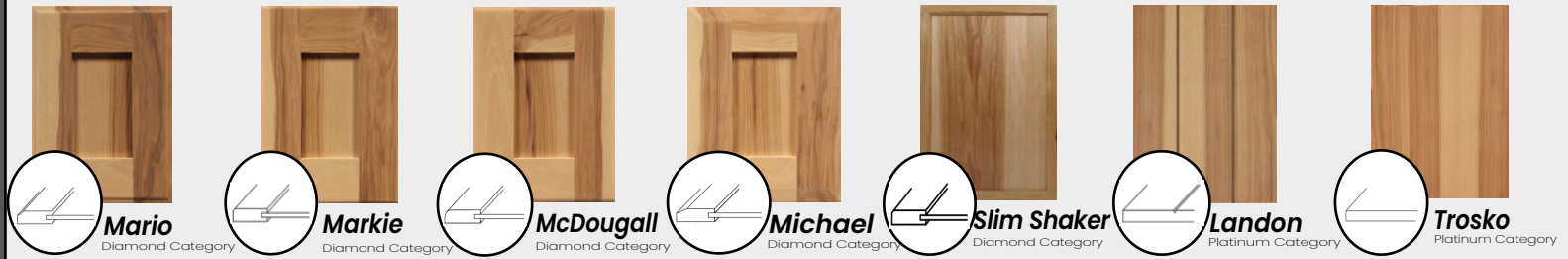

STAIN OPTIONS

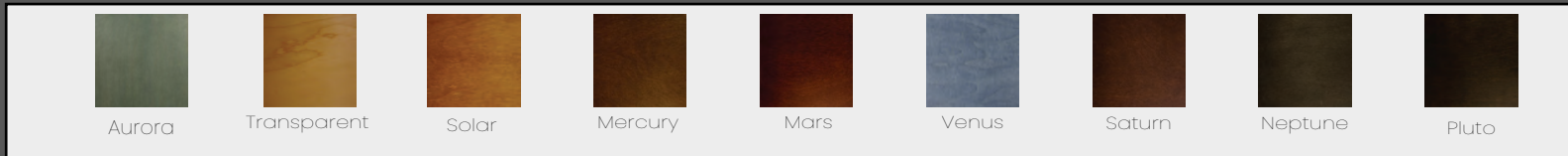

Earth Series



CHERRY DOORS

Adding value to any home, cherry is often considered the king of cabinet woods. Taking all finishes well, its variable and unique grain pattern provides an air of refined luxury.

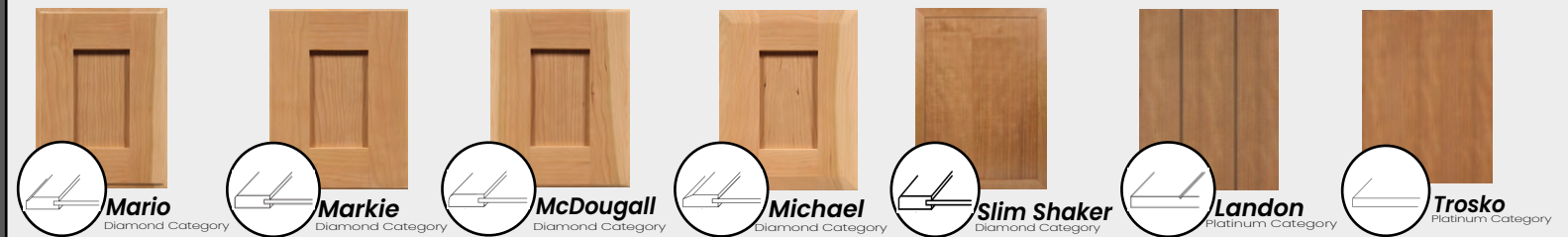

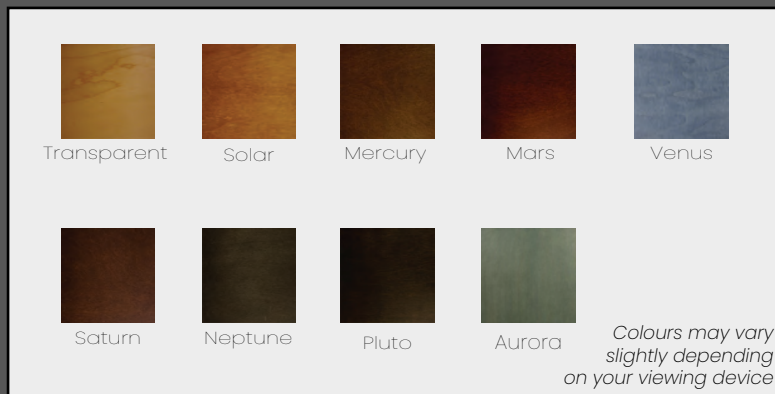

STAIN OPTIONS







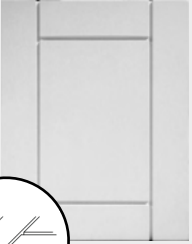

MDF DOORS

COLOURS

We use the highest quality Medium Density Fiberboard (MDF) available. MDF is a high grade composite material made from recycled wood. Its unmatched dimensional stability makes it the best choice for painted surfaces.





 Alanna Silver Category	 Chand Gold Category	 Joanne Gold Category	 Landon Gold Category
 Lucia Gold Category	 Mario Platinum Category	 Markie Platinum Category	 McDougall Platinum Category
 Michael Platinum Category	 Slim Shaker Platinum Category	 Trosko Gold Category	 Wayne Gold Category

	White
	Cream
	Antique White
	Grey White
	Grey
	Willow
	*Custom

Colours may vary slightly depending on your viewing device

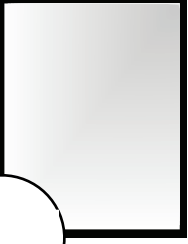
POLYMER DOORS

Polymer surfaces provide the most durable and scratch resistant gloss finish. Superior to vinyl by a wide margin, polymer doors are the perfect choice for a clean, modern look.

 HG White Gold Category	 HG Gentle Grey Gold Category	 HG Grey Gold Category	 HG Black Gold Category
---	---	---	---

Colours may vary slightly depending on your viewing device

NEXTEK SHAKER DOORS

GOLD CATEGORY

Nextek doors feature a new polymer laminate material that is superior to all known cabinet finishes. It is more affordable, consistent and durable than wood or vinyl, and highly resistant to heat, chemicals and scratching.



Black Rio



Cannes



Cassis



Chill



Driftwood



Esterel



Haze



Latitude North

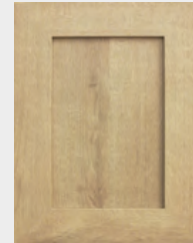

Mistral



Monaco



Nizza



Silva



Skye



Storm

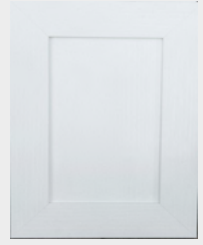

White Rio

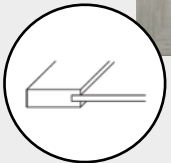

Edge Profile

NEXTEK CHAMFER DOORS

GOLD CATEGORY
Plus Special Setup



Cassis

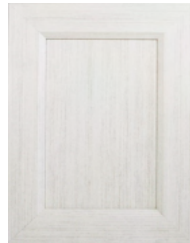

Chill



Nizza

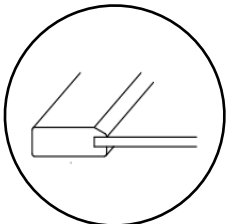

Edge Profile



TFL DOORS

Superior to vinyl, Thermally Fused Laminate is a composite material of exceptional hardness. Inexpensive, durable and beautiful laminate doors come in a wide variety of colours, textures, and edge treatments.



Navin - Colour Match

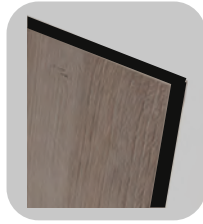

Karen - 2mm Black



Karen - 2mm White

GOLD CATEGORY



Black Rio



Cannes



Cassis



Chill



Driftwood



Esteral



Haze



Latitude North



Mistral



Monaco

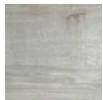

Nizza



Silva



Skye



Storm



White Rio

BRONZE CATEGORY



Antique White

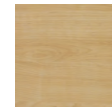

Del Maple

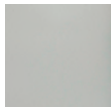

Custom Grey



White

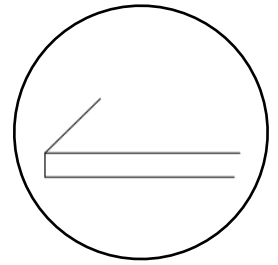

Edge Profile

VELOUR TOUCH DOORS

GOLD CATEGORY

Featuring a smooth, shine-free finish, these doors are also manufactured in Alberta and provide that matte finish that adds class to any room. This is the latest in design choices and is easy to clean.



Bamboo Shoots



Cashmere Dusk



Cotton Mist



Jersey Fog



Oxford Grey



Suede Stone



Velour Black

GLASS DOORS

In keeping with our theme of customization, add a touch of elegance and class - with glass! Available in two thicknesses and a variety of styles to choose from. Each style is also available in tempered glass.

REGULAR GLASS



Pinhead



3mm Clear



Rain

SPECIAL GLASS

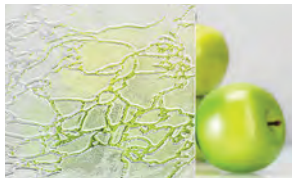

Delta Frost



Glue Chip



Grey Tint



Krinkle

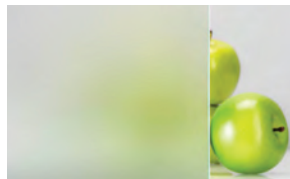

Satin Etch

DOOR HANDLES

Complete your cabinetry's new look with our large variety of handles. The extensive selection will leave you with plenty of options for your perfect space. Stocking handles are ready and on site.

STOCKING



BP10734900
(Matte Black)



BP8041195
(Brushed Nickel)



33205195
(Brushed Nickel)



BP82196195
(Brushed Nickel)



BP9161196195
(Brushed Nickel)



BP65017900
(Matte Black)



16338195
(Brushed Nickel)



BP820128195
(Brushed Nickel)



650020128195
(Brushed Nickel)



650020128900
(Matte Black)



BP805128195
(Brushed Nickel)



305128195
(Brushed Nickel)



BP650128195
(Brushed Nickel)



BP821128195
(Brushed Nickel)



BP814332900
(Matte Black)



BP260637BORB
(Brushed Oil - Rubbed Bronze)



82905128195
(Brushed Nickel)



BP5016128195
(Brushed Nickel)



BP5016128BORB
(Brushed Oil - Rubbed Bronze)



BP2606128195
(Brushed Nickel)



BP2606128BORB
(Brushed Oil - Rubbed Bronze)



BP2606128143
(Antique Nickel)



51278128195
(Brushed Nickel)



56206128195
(Brushed Nickel)



BP82871128195
(Brushed Nickel)



BP82871128158
(Brushed Aurum Gold)



BP82871128140
(Chrome)



BP82871128900
(Matte Black)



BP810128143
(Antique Nickel)



BP811128195
(Brushed Nickel)



BP8160128195
(Brushed Nickel)



BP8160128900
(Matte Black)



BP8160128160
(Brushed Aurum Gold)



BP7340128195
(Brushed Nickel)



BP7340128900
(Matte Black)

TOP ("T") CABINET - ONE DOOR

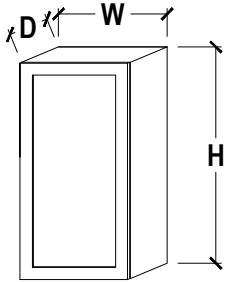

STANDARD SIZES (CUSTOM SIZES AVAILABLE UPON REQUEST)

WIDTHS	HEIGHTS
9"W	13"H
12"W	30"H
15"W	36"H
18"W	39"H
21"W	42"H

CABINET CODE EX) T1530

* STANDARD TOP CABINET BOX IS 11 7/8"D

TOP ("T") CABINET - TWO DOORS

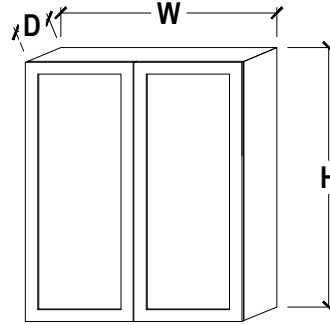

STANDARD SIZES (CUSTOM SIZES AVAILABLE UPON REQUEST)

WIDTHS	HEIGHTS
24"W	13"H
27"W	30"H
30"W	36"H
33"W	39"H
36"W	42"H
39"W	

CABINET CODE EX) T3036

* STANDARD TOP CABINET BOX IS 11 7/8"D

TOP ("T-ED") CABINET - EXTRA DEEP

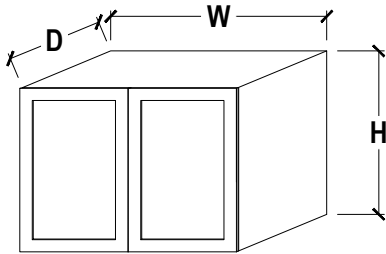

STANDARD SIZES (CUSTOM SIZES AVAILABLE UPON REQUEST)

WIDTHS	HEIGHTS
30"W	13"H
33"W	19"H
36"W	22"H
39"W	25"H

CABINET CODE EX) T3319ED

*STANDARD EXTRA DEEP TOP CABINET BOX IS 23 1/2"D

TOP ("TA") CABINET - ANGLED CORNER

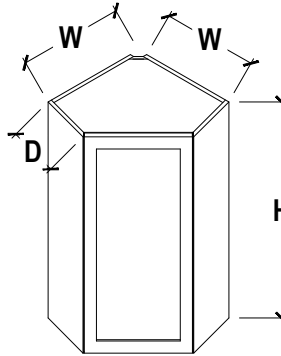

STANDARD SIZES (CUSTOM SIZES AVAILABLE UPON REQUEST)

WIDTHS	HEIGHTS
21"W	30"H
24"W	36"H
	39"H
	42"H

CABINET CODE EX) TA2436

* STANDARD TOP ANGLED CABINET BOX IS 11 7/8"D

COUNTERTOP ("CT") CABINET - TWO DOORS

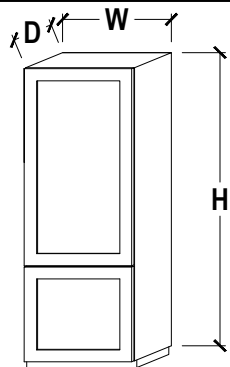

STANDARD SIZES (CUSTOM SIZES AVAILABLE UPON REQUEST)

WIDTHS	HEIGHTS
12"W	48"H
15"W	54"H
18"W	57"H
21"W	60"H

CABINET CODE EX) CT1854

*STANDARD COUNTERTOP CABINET BOX IS 11 7/8"D

COUNTERTOP ("CT") CABINET - FOUR DOORS

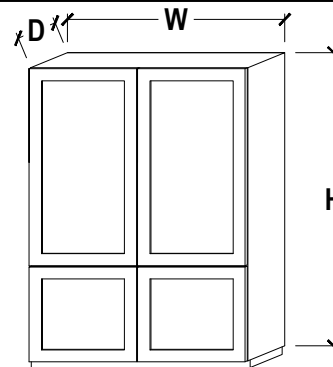

STANDARD SIZES (CUSTOM SIZES AVAILABLE UPON REQUEST)

WIDTHS	HEIGHTS
24"W	48"H
27"W	54"H
30"W	57"H
33"W	60"H
36"W	

CABINET CODE EX) CT3660

*STANDARD COUNTERTOP CABINET BOX IS 11 7/8"D

BASE ("B") CABINET - ONE DOOR

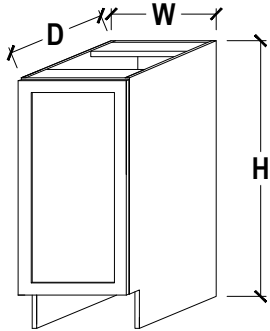

STANDARD SIZES

(CUSTOM SIZES AVAILABLE UPON REQUEST)

WIDTHS

9"W
12"W
15"W
18"W
21"W

CABINET CODE EX) B15

*STANDARD BASE CABINET BOX IS 34 3/4"H X 23 1/2"D

BASE ("B") CABINET - TWO DOORS

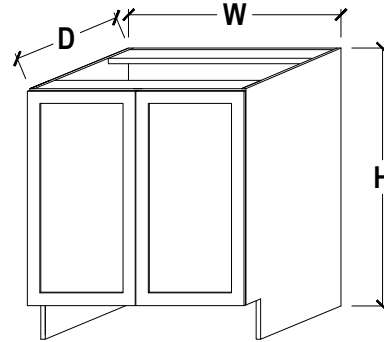

STANDARD SIZES

(CUSTOM SIZES AVAILABLE UPON REQUEST)

WIDTHS

24"W
27"W
30"W
33"W
36"W
39"W

CABINET CODE EX) B36

* STANDARD BASE CABINET BOX IS 34 3/4"H X 23 1/2"D

BASE SINK ("BS") CABINET - NO SINK PANEL

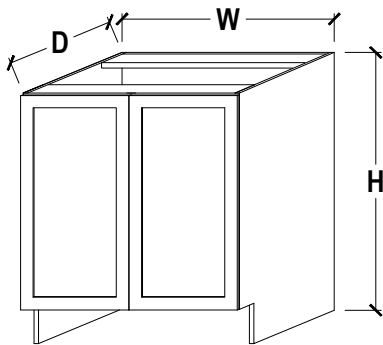

STANDARD SIZES

(CUSTOM SIZES AVAILABLE UPON REQUEST)

WIDTHS

24"W
27"W
30"W
33"W
36"W
39"W

MAPLE RAIL ADDED FOR SINK SUPPORT CABINET CODE EX) BS36

* STANDARD BASE CABINET BOX IS 34 3/4"H X 23 1/2"D

BASE SINK ("BSP") CABINET - SINK PANEL

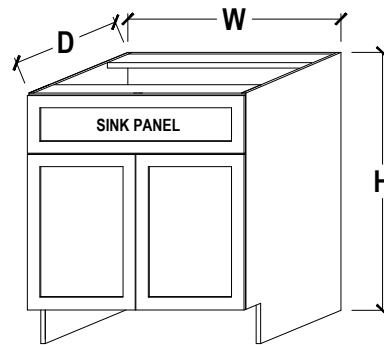

STANDARD SIZES

(CUSTOM SIZES AVAILABLE UPON REQUEST)

WIDTHS

24"W
27"W
30"W
33"W
36"W
39"W

MAPLE RAIL ADDED FOR SINK SUPPORT CABINET CODE EX) BSP36

* STANDARD BASE CABINET BOX IS 34 3/4"H X 23 1/2"D

BASE ("BD") CABINET - ONE DOOR & DRAWER

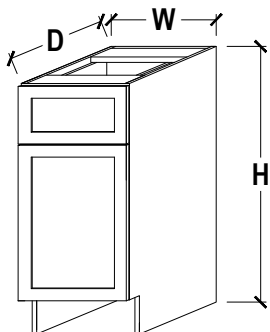

STANDARD SIZES

(CUSTOM SIZES AVAILABLE UPON REQUEST)

WIDTHS

9"W
12"W
15"W
18"W
21"W

CABINET CODE EX) BD12

*STANDARD BASE CABINET BOX IS 34 3/4"H X 23 1/2"D

BASE ("BD") CABINET - TWO DOORS & ONE DRAWER

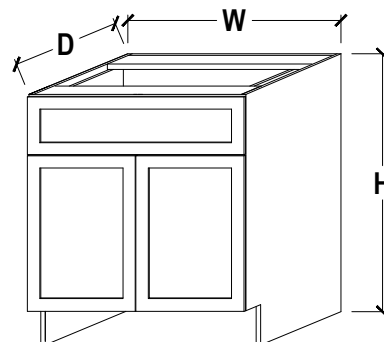

STANDARD SIZES

(CUSTOM SIZES AVAILABLE UPON REQUEST)

WIDTHS

24"W
27"W
30"W
33"W
36"W
39"W

CABINET CODE EX) BD30

* STANDARD BASE CABINET BOX IS 34 3/4"H X 23 1/2"D

BASE BANK OF 2 DRAWERS ("B2D") CABINET

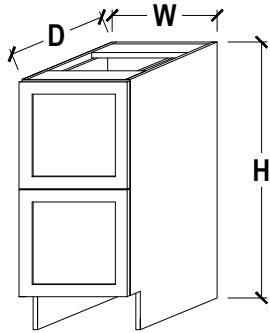

STANDARD SIZES

(CUSTOM SIZES AVAILABLE UPON REQUEST)

WIDTHS

12"W	27"W
15"W	30"W
18"W	33"W
21"W	36"W
24"W	39"W

CABINET CODE EX) B2D27

*STANDARD BASE CABINET BOX IS 34 3/4"H X 23 1/2"D

BASE BANK OF 3 DRAWERS ("B3D") CABINET

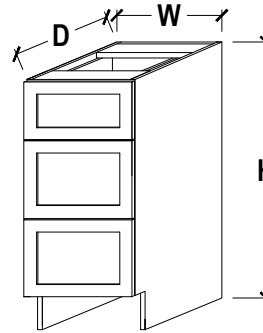

STANDARD SIZES

(CUSTOM SIZES AVAILABLE UPON REQUEST)

WIDTHS

12"W	27"W
15"W	30"W
18"W	33"W
21"W	36"W
24"W	39"W

CABINET CODE EX) B3D24

*STANDARD BASE CABINET BOX IS 34 3/4"H X 23 1/2"D

BASE BANK OF 4 DRAWERS ("B4D") CABINET

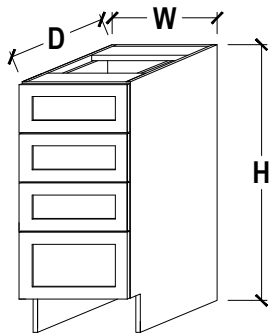

STANDARD SIZES

(CUSTOM SIZES AVAILABLE UPON REQUEST)

WIDTHS

12"W	27"W
15"W	30"W
18"W	33"W
21"W	36"W
24"W	39"W

CABINET CODE EX) B4D24

*STANDARD BASE CABINET BOX IS 34 3/4"H X 23 1/2"D

BASE ("BK") CABINET - 90° CORNER BI-FOLD

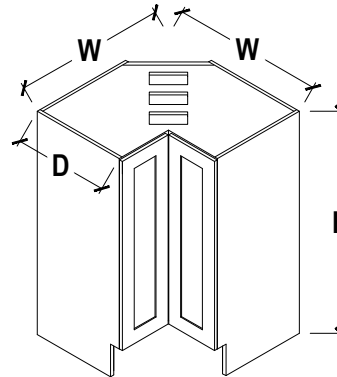

STANDARD SIZES

(CUSTOM SIZES AVAILABLE UPON REQUEST)

WIDTHS

33" X 33"W
36" X 36"W
39" X 39"W

CABINET CODE EX) BK3636

*STANDARD BASE CABINET BOX IS 34 3/4"H X 23 1/2"D

BASE ("BC") CABINET - BLIND CORNER

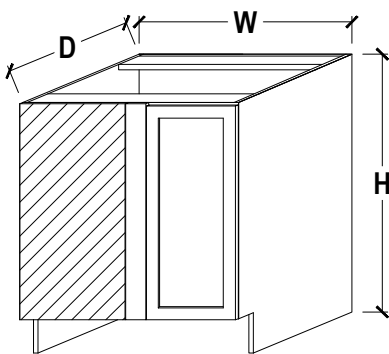

STANDARD SIZES

(CUSTOM SIZES AVAILABLE UPON REQUEST)

WIDTHS

36"W
39"W
42"W

AVAILABLE IN LEFT &
RIGHT VERSIONS

CABINET CODE EX) BC39

*STANDARD BASE CABINET BOX IS 34 3/4"H X 23 1/2"D

BASE ("BA") CABINET - ANGLED CORNER

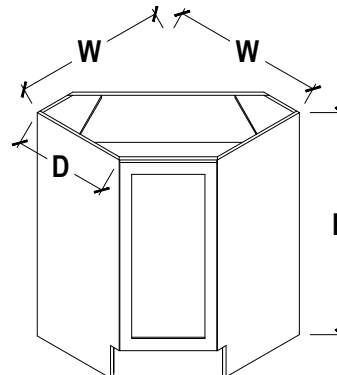

STANDARD SIZES

(CUSTOM SIZES AVAILABLE UPON REQUEST)

WIDTHS

39"W - ONE DOOR
42"W - TWO DOORS

CABINET CODE EX) BA39

*STANDARD BASE CABINET BOX IS 34 3/4"H X 23 1/2"D

KITCHEN LOWER

BASE ("BASP") CABINET - ANGLED CORNER w/ SINK PANEL

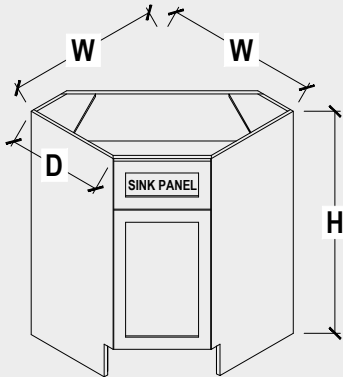

STANDARD SIZES

(CUSTOM SIZES AVAILABLE UPON REQUEST)

WIDTHS

39"W - ONE DOOR
42"W - TWO DOORS

CABINET CODE EX) BASP39

*STANDARD BASE CABINET BOX IS 34 3/4"H X 23 1/2"D

BASE ("BAE") CABINET - ANGLED END

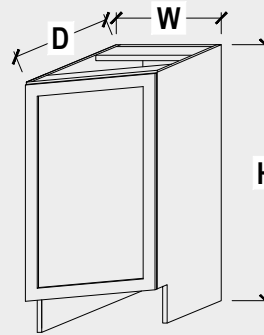

STANDARD SIZES

(CUSTOM SIZES AVAILABLE UPON REQUEST)

WIDTHS

12"W
15"W

AVAILABLE IN LEFT &
RIGHT VERSIONS

CABINET CODE EX) BAE15

*STANDARD BASE CABINET BOX IS 34 3/4"H X 23 1/2"D

PANTRIES

PANTRY ("P") CABINET - THREE DOORS



STANDARD SIZES

(CUSTOM SIZES AVAILABLE UPON REQUEST)

WIDTHS	HEIGHTS
12"W	84"H
15"W	90"H
18"W	93"H
21"W	96"H

CABINET CODE EX) P1893

MIDDLE AND BOTTOM
DOORS PINNED
TOGETHER

BROOM PANTRY
CONFIGURATION
AVAILABLE

BUILT AS ONE WHOLE
UNIT

*STANDARD PANTRY CABINET BOX IS 23 1/2"D

PANTRY ("P") CABINET - SIX DOORS

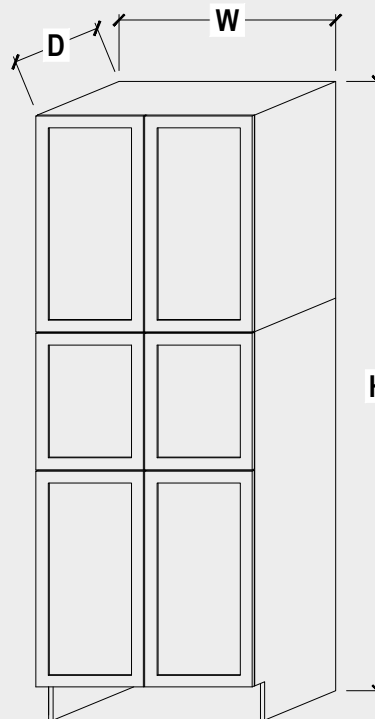

STANDARD SIZES

(CUSTOM SIZES AVAILABLE UPON REQUEST)

WIDTHS	HEIGHTS
24"W	84"H
27"W	90"H
30"W	93"H
33"W	96"H
36"W	

CABINET CODE EX) P3396

MIDDLE AND BOTTOM
DOORS PINNED
TOGETHER

BROOM PANTRY
CONFIGURATION
AVAILABLE

BUILT IN TWO UNITS AND
ASSEMBLED ON SITE

*STANDARD COUNTERTOP CABINET BOX IS 23 1/2"D

VANITY ("VD") CABINET - ONE DOOR & DRAWER

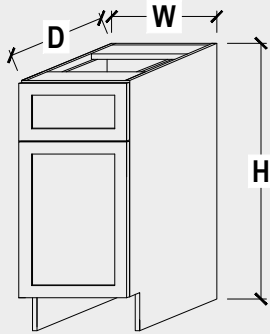

STANDARD SIZES

(CUSTOM SIZES AVAILABLE UPON REQUEST)

WIDTHS

9"W
12"W
15"W
18"W
21"W

CABINET CODE EX) VD15

*STANDARD VANITY CABINET BOX IS 31 1/8"H X 20 1/2"D

VANITY ("VD") CABINET - TWO DOORS & ONE DRAWER

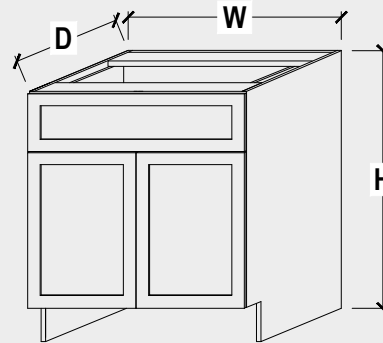

STANDARD SIZES

(CUSTOM SIZES AVAILABLE UPON REQUEST)

WIDTHS

24"W

CABINET CODE EX) VD24

*STANDARD VANITY CABINET BOX IS 31 1/8"H X 20 1/2"D

VANITY BANK OF 3 DRAWERS ("V3D") CABINET

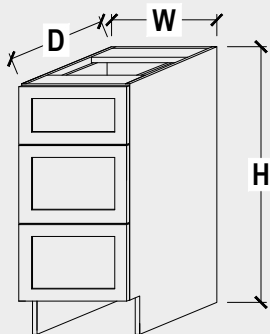

STANDARD SIZES

(CUSTOM SIZES AVAILABLE UPON REQUEST)

WIDTHS

12"W
15"W
18"W
21"W
24"W

CABINET CODE EX) V3D24

*STANDARD VANITY CABINET BOX IS 31 1/8"H X 20 1/2"D

VANITY SINK ("VSP") CABINET - ONE DOOR

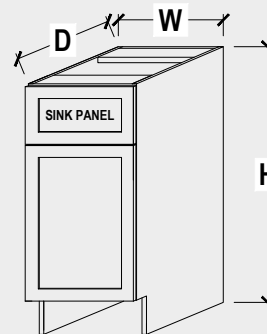

STANDARD SIZES

(CUSTOM SIZES AVAILABLE UPON REQUEST)

WIDTHS

18"W
21"W

CABINET CODE EX) VSP21

MAPLE RAIL ADDED FOR SINK SUPPORT

*STANDARD VANITY CABINET BOX IS 31 1/8"H X 20 1/2"D

VANITY SINK ("VSP") CABINET - TWO DOORS

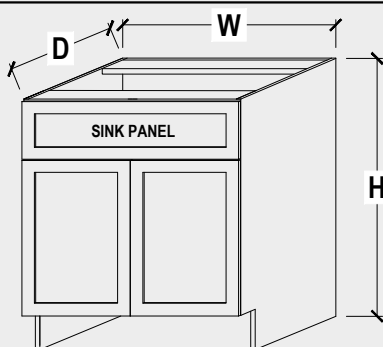

STANDARD SIZES

(CUSTOM SIZES AVAILABLE UPON REQUEST)

WIDTHS

24"W
27"W
30"W
33"W
36"W
39"W

MAPLE RAIL ADDED FOR SINK SUPPORT

CABINET CODE EX) VSP36

* STANDARD BASE CABINET BOX IS 31 1/8"H X 20 1/2"D

VANITY SINK ("VSD") CABINET - ONE DOOR & TWO DRAWERS

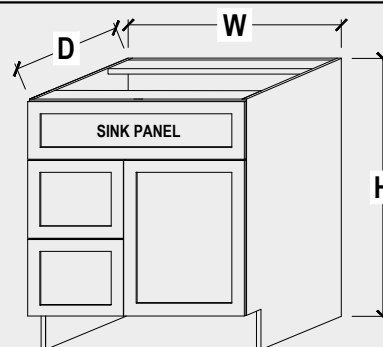

STANDARD SIZES

(CUSTOM SIZES AVAILABLE UPON REQUEST)

WIDTHS

30"W
33"W

CABINET CODE EX) VSD30

AVAILABLE IN LEFT &
RIGHT VERSIONS

MAPLE RAIL ADDED FOR SINK SUPPORT

* STANDARD BASE CABINET BOX IS 31 1/8"H X 20 1/2"D

BATHROOM

VANITY SINK ("VSBD") CABINET - TWO DOORS & DRAWERS

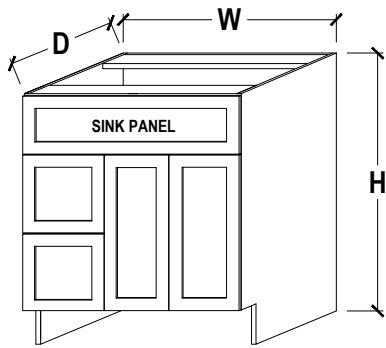

STANDARD SIZES

(CUSTOM SIZES AVAILABLE UPON REQUEST)

WIDTHS

36"W

39"W

CABINET CODE EX) VSBD36

AVAILABLE IN LEFT & RIGHT VERSIONS

MAPLE RAIL ADDED FOR SINK SUPPORT

* STANDARD BASE CABINET BOX IS 31 1/8"H X 20 1/2"D

VANITY SKIRT ("VDSKIRT") CABINET - ONE DRAWER

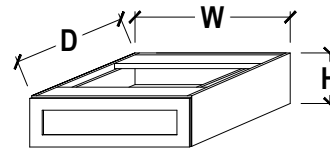

STANDARD SIZES

(CUSTOM SIZES AVAILABLE UPON REQUEST)

WIDTHS

24"W

27"W

30"W

33"W

36"W

TYPICALLY USED FOR A MAKEUP VANITY OR DESK

CABINET CODE EX) VDSKIRT30

*STANDARD VANITY SKIRT BOX IS 7 1/4"H X 20 1/2"D

CLOSETS

WARDROBE TOP ("WT") CABINET

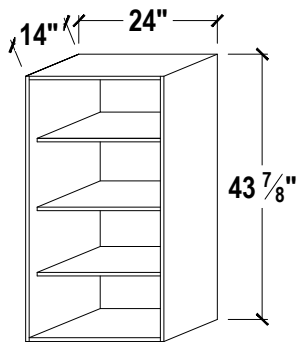

ONE STANDARD SIZE
24"W X 43 7/8"H X 14"D

CUSTOM SIZES AVAILABLE UPON REQUEST - EXTRA DESIGN CONSIDERATIONS REQUIRED

FULLY FINISHED ALL AROUND

CABINET CODE EX) WT24

WARDROBE BASE ("WB") CABINET

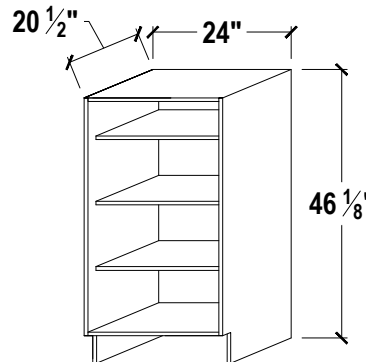

ONE STANDARD SIZE
24"W X 46 1/8"H X 20 1/2"D

CUSTOM SIZES AVAILABLE UPON REQUEST - EXTRA DESIGN CONSIDERATIONS REQUIRED

FULLY FINISHED ALL AROUND

CABINET CODE EX) WB24

WARDROBE BANK OF DRAWERS ("WB4D") CABINET

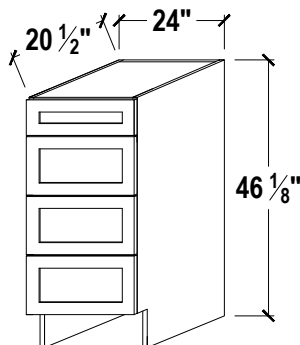

ONE STANDARD SIZE
24"W X 46 1/8"H X 20 1/2"D

CUSTOM SIZES AVAILABLE UPON REQUEST - EXTRA DESIGN CONSIDERATIONS REQUIRED

FULLY FINISHED ALL AROUND INCLUDING DRAWER BOXES

CABINET CODE EX) WB4D24

CLOSET OPTIONS

ROD - HEAVY DUTY CLOSET ROD AVAILABLE IN LENGTHS OF 3, 4, 6, 8, & 12 FEET

FLANGE - CIRCULAR SUPPORTS FOR ROD TO SIT IN - INSTALLED ON FILLS ATTACHED TO WALL

MID SUPPORTS - BRACKETS TO SUPPORT THE MIDDLE OF RODS AND SHELVES

CLOSET SHELF - 15" DEEP SHELF TYPICALLY INSTALLED OVER A CLOSET ROD

SHOE SHELF - ANGLED SHOE SHELF TYPICALLY INSTALLED IN THE WARDROBE TOP CABINET

SHOE ROLLOUT SHELF - TYPICALLY INSTALLED IN THE WARDROBE BASE CABINET

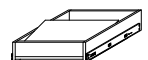
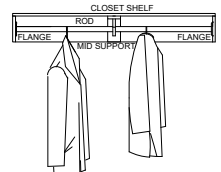

SEAT ("S") CABINET - ONE DOOR**STANDARD SIZES**

(CUSTOM SIZES AVAILABLE UPON REQUEST)

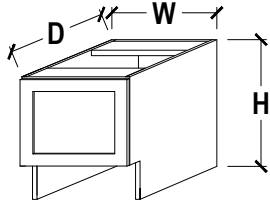
**WIDTHS**

15"W

18"W

CABINET CODE EX) S15

STANDARD SEAT CABINET BOX IS 17 3/4"H X 20 1/2"D*SEAT ("S") CABINET - TWO DOOR****STANDARD SIZES**

(CUSTOM SIZES AVAILABLE UPON REQUEST)

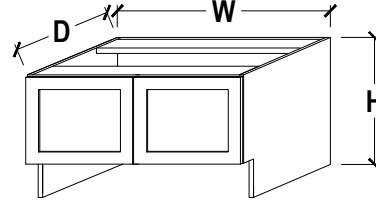
**WIDTHS**

24"W

30"W

36"W

CABINET CODE EX) S30

STANDARD SEAT CABINET BOX IS 17 3/4"H X 20 1/2"D*SEAT ("SD") CABINET - ONE DRAWER****STANDARD SIZES**

(CUSTOM SIZES AVAILABLE UPON REQUEST)

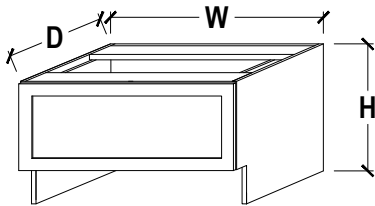
**WIDTHS**

15"W

18"W

24"W

30"W

36"W

CABINET CODE EX) SD24

***STANDARD SEAT CABINET BOX IS 17 3/4"H X 20 1/2"D**

**WE OFFER A VARIETY OF CABINET MODIFICATION
OPTIONS AND ACCESSORIES TO GIVE A CUSTOM FEEL
WITHOUT THE CUSTOM PRICES!
SEE IN STORE FOR DETAILS.**